



ATL1010W

FULLY AUTOMATIC WASHING MACHINE

---

## Operation Manual

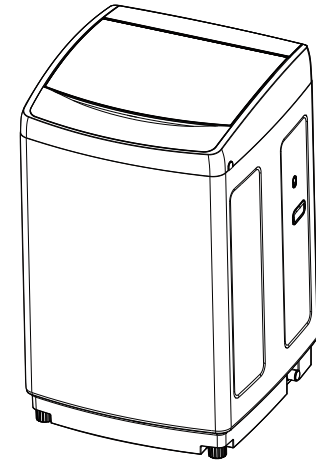

10.0kg

It is most important that this instruction book should be retained with the appliance for future reference. Should the appliance be sold or transferred to another owner, or should you move house and leave the appliance, always ensure the book is supplied with the appliance in order that the new owner can get to know the functioning of the appliance and the relevant warnings. These warnings have been provided in the interest of safety. You must read them carefully before installing or using the appliance.

# Contents

<b>Before using</b>	
Parts name.....	1
Cautions.....	2
Installation and adjustment.....	4
How to use drain hose.....	5
Water inlet installation.....	6
<b>Operation</b>	
Preparation before operation.....	7
Load clothes.....	8
Use of detergent.....	9
Control panel instructions.....	10
Program.....	12
Maintenance.....	13
Troubleshooting.....	14
<b>Others</b>	
Other functions.....	16
Specification.....	17

# Specification

Model	ATL1010W
Rated capacity of wash and spin	10.0kg
Rated voltage and frequency	220-240V~·50Hz
Water level/water volume (about)	10/97L 9/85L 8/76L 7/67L 6/59L 5/53L 4/47L 3/41L 2/36L 1/31L
Inlet pressure	0.05MPa-0.85MPa
Rated input power	Wash: 400W spin: 340W
Weight	About 52.5kg
Product Dimensions	W665mm D675mm H1060mm

# Other functions

## 1. Abnormal display

Display	Explanation	Troubleshooting
E0	The top lid is opened when preset is started	Close the top lid and clear the alarm
E1	After draining for 7 minutes, it still does not reach to the minimum of water level	Please refer to Page 14 &15 for troubleshooting
E2	The top lid open when spinning	Close the top lid and clear the alarm
E3	Spin is not balanced	Open the top lid, place the clothes equally, then close it and clear the alarm
E4	After inflow of water for 40 minute, it still does not reach to the water level set	Please refer to Page 14 &15 for troubleshooting
E5 child-lock light flashing	The top lid is opened after setting child-lock	Close the top lid and clear the alarm
F1	Water Level sensor is abnormal	Cut off the power supply and contact an Authorised Service Agent to assist
F2	inverter signal communication wrong	

## 2. Imbalance adjustment

During spinning, if the clothes are not placed equally in the tub, it would cause violent vibration. This machine has imbalance adjustment function, and the vibration testing system will supervise the running. Once vibration is beyond certain level, the adjustment system will start automatically to adjust the imbalance.

## 3. Power supply is cut off automatically

- If you did not start the program in 10 minutes after pressing the power supply button, the power supply will be cut off automatically.
- After the washing is finished, alarm buzzes and the power supply will cut off automatically.

## 4. Child lock function

- When child lock function is set, all the buttons will be locked including POWER. If the top lid is opened during the washing machine working, the washing will be stopped and give an alarm. But if you can close the top lid in 5 seconds, the alarm will stop and the washing machine will continue working. If cannot close the top lid in 5 seconds, the washing machine will begin draining if there is water in the inner tub, even closing the top lid is not valid. During the draining, alarm will buzz every 10 seconds, when the water in the inner tub is about 5cm higher, alarm will buzz every 10 minutes. When the draining is finished, the washing machine will be in the state of waiting, if close the top lid, the washing machine is unlocked and start working as previous setting.
- Once child lock is set, if top lid is opened over 5 seconds during washing or rinse (there is water in the inner tub), washing machine will drain and alarm will buzz. If you unlock the function during draining, the washing machine will add water to water level set and continue working.

## 5. Water recycle function

When water recycle function is set, after the last rinse finished, the washing machine will not drain and spin. SPIN and WATER RECYCLE indicator light will be flashing and alarm will be given, the washing machine will stop working (if nobody operate, the alarm will be given every 10 minutes, in 1 hour, power supply will be cut off automatically). When press START/PAUSE, WATER RECYCLE indicator light is on and the washing machine begin to drain and spin, the user can reuse the water.

## 6. Inverter washing function

Direct Drive motor is used on this machine. At the beginning of start, if you want to choose a different washing speed and spinning speed on the initial state, pressing "WATER LEVEL" button and press "PRESET/AIR DRY/SPEED" button, choose inverter wash and inverter spin (This function is only applicable to "COTTON" and "HEAVY" program). And then press "PRESET/AIR DRY/SPEED" button, choose different washing speed and spinning speed to suit different clothes and achieve better washing and spinning

# Parts name

# Before using

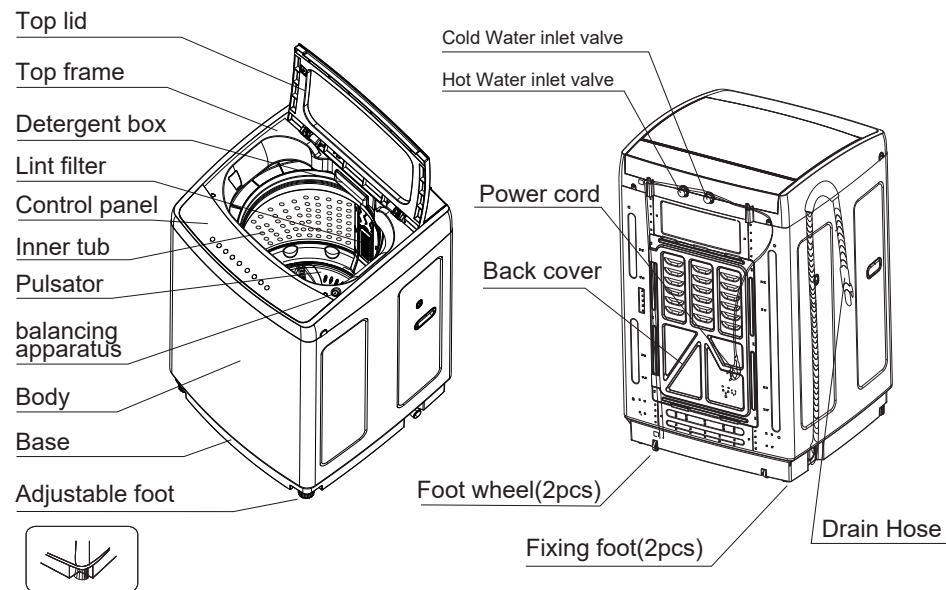

## Accessories

Bottom cover (1pc)	The end connect to the appliance The end connect to water inlet hose connector Water inlet hose (2pc)	Outfall stopper (1pcs)

## Symbol definition

Warning symbols 	Pay special attention to the warning symbols. There may be serious risks to personal body safety or damages to the washing machine if not follow.
Forbidden symbols 	Please stop doing the contents with this symbol, otherwise it will damage the appliance or injure your personal body.

# Cautions

## Before using

This appliance is intended to be used in household and similar applications such as:

- Staff kitchen areas in shops, offices and other working environments;
- Farm houses;
- By clients in hotels, motels and other residential type environments;
- Bed and Breakfast type environments

Please insert the plug into the power socket with rated voltage 220-240V A/C.

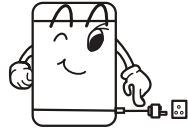

Always unplug the appliance and turn off the water when the power is cut, moving or cleaning the washing machine, or it is not in use. Do not insert or pull off the plug with wet hand.

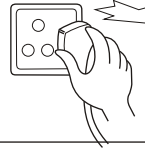

Do not make the electric cable bended, stretched, twisted, strapped or changed, pressed or nipped. If the supply cord is damaged, it must be replaced by the manufacturer, its service agent or similarly qualified persons in order to avoid a hazard. The pin of the plug must remain clean. Please clean it carefully with dry cloth if it is dirty.



Do not install the washing machine in bathroom or damp places. Do not wash the machine with water, do not put wet clothes on the control panel film.

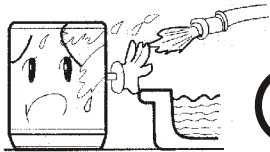

Do not use water hotter than 50°C



If the machine is situated on a carpeted floor, please adjust the feet in order to allow air to circulate freely.

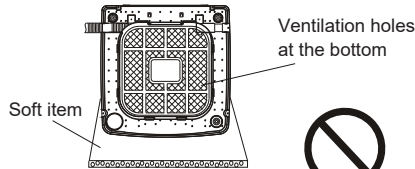

Do not wash raincoat, bike cover, feather dress and waterproof clothes, which will cause the washing machine to have abnormal vibrations during spinning.



Do not share the same socket with other electric appliances. Do not use the damaged plug or loose socket.

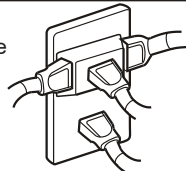

# Troubleshooting

Troubleshooting	
	<p>Insert the plug tightly Check the socket or change to another socket Press power switch Check power supply</p>
	<p>Install the inlet hose again Tighten the connector of the machine</p>
	<p>The height of the drain hose should be less than 1.2m Straighten or clean the drain hose</p>
	<p>Restart when water supply is resumed Open the tap Clean the filter according to before "clean inlet gate"</p>
	<p>The machine is adjusting automatically</p>
	<p>Close the top lid Close the top lid</p>
	<p>Normal</p>
	<p>Normal</p>

Notes : If there is still a fault after the above checks, please pull out the plug and contact the Authorised Service Agent right away. It is dangerous to repair this product by yourself.

# Troubleshooting

Before contacting the technicians, please make the following checks:

Issue	Possible reason
Control panel has no display	Plug is not inserted tightly No electricity in the socket Power switch is not turned on Power supply is cut off
Inlet hose leaks	Inlet hose connector(connecting with the tap)is not fixed tightly Inlet hose and washing machine connector is loose
It does not drain	Water outlet of drain hose is higher than 1.2m Drain Hose is bent or blocked
No inflow of water	No water supply Tap is not open Inlet hose gets blocked
Spin stops and water inflow begins during spin program	Clothes is too much or too little or the machine is not stable
Press the program button to select SPIN, but It does not spin	Top lid was not closed when drain is finished Top lid was open when drain is started
The spin is intermittent when spin starts	Balance the clothes to reach to the best spin effect
First time use, some water flows out from the drain hose	The remaining water from factory's testing

# Cautions

## Before using

Do not put hands into the working machine. It is dangerous even if the speed is very slow. Take special care of the children, and forbid them to climb on the washing machine.



It is dangerous to alter the specifications or attempt to modify this product in any way.

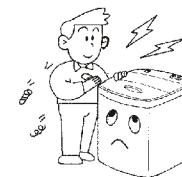

Do not overload the appliance or put any hot goods(such as the kettle with hot water)on the washing machine.



Garments which have been in contact with volatile petroleum products should not be machine washed.

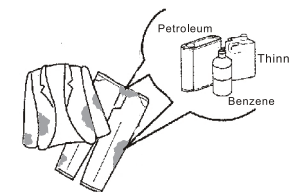

This appliance is not intended for use by persons (including children) with reduced physical, sensory or mental capabilities, or lack of experience and knowledge, unless they have been given supervision or instruction concerning use of the appliance by a person responsible for their safety. Children should be supervised to ensure that they do not play with the appliance.



Keep the appliance away from direct sunlight and heat sources like the heater.

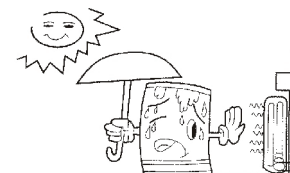

Any objects such as coins, safety pins, nails, screws, stones or any other hard, sharp material can cause extensive damage and must not be placed into the machine.



- Before washing, please ensure the tap is open and the inlet hose is installed properly.
- It is suggested to use low foam washing powder.

Please install and adjust the machine according to the requirements of the manual. Correct operation is very important for your safety.

### Unpacking

- Unpack the carton and take out the bottom cover.
- Open the top lid of washing machine and take out all of the accessories.
- Remove all wrappers, including the polystyrene base. You are advised to keep all the packaging for reuse in case the machine is to be transported again.

### Installing the bottom cover

- Let the back of washing machine incline forward, make the side of bottom cover with sticker description back to washing machine, insert to the bottom of washing machine along the direction of arrow.
- Remove two fixing clamp by scissors, insert to the accordingly holes black lines indicating ( gently pull fixing clamp should not be pulled out ), make the bottom cover fixed on the base.

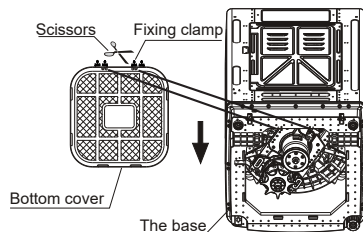

### Positioning

The distance between the washing machine and the wall should be more than 50mm, and the maximum allowed angle of the shank base of the machine is 1°. The slanting or rough ground may cause operating stopped or unstable, please adjust it with the following methods:

- Horizontal checking  
Use a spirit level to check the level of your machine. Observe the water bubble in balancing apparatus is in red circle or not. In red circle, it is horizontal.

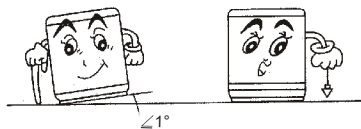

- Adjust the adjustable foot

- 1) Lift up the adjustable foot gently, loosen the adjustable nut and twist the adjustable foot.
- 2) Fasten the nut after adjustment.
- 3) Set the machine flat, and observe again. If the water bubble is not in red circle, repeat the above procedure, till the water bubble is in red circle.

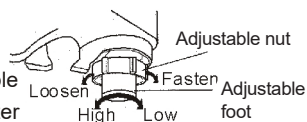

### Maintenance methods

#### After the end of the programme

- The machine stops automatically, and music buzzer will remind you to take out the clothes or start again.
- Once you have finished using the machine, you are advised to unplug it and turn off the water taps to avoid unexpected leak or fire.

#### External cleaning

Clean the exterior cabinet of the appliance with soft cloth. Do not use cleanser, volatile chemical materials to clean the machine, which will damage plastic parts and the surface.



#### Magic filter cleaning

1. pull out magic filter
2. open the box and clean it
3. close it and reinstall it
4. check if the lint block part is in good condition

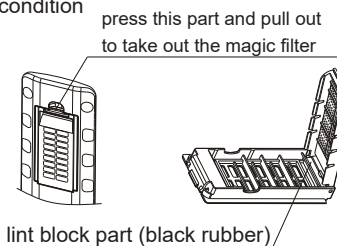

#### Clean the lint filter

It is possible that the inlet filter net can be blocked by the dust, please clean it according to the following steps:

1. Close the tap and turn on the power switch.
2. Start the washing machine for 5 seconds (make the water in the inlet hose flows to the tub), and cut off the power supply.
3. Pull off the inlet hose, remove and clean the inlet valve and the inlet net, and install again.

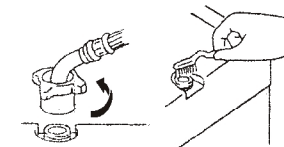

1. After using the machine, you are advised to turn off the water taps. (if necessary, pull out the inlet hose).
2. Do not keep water in tub for a long time. When washing is finished, drain it right away.
3. Once you have finished using the machine, you are advised to unplug it.
4. Put the electric cable and the drain hose in order.
5. Wipe the water on the surface and in the tub with soft cloth and keep the top lid opened for a while. It helps to prevent mold and smell forming inside the appliance. If the water in the inner tub has possibility to freeze, please follow as below:
  - a) In winter, any remaining water may freeze and can cause the washing machine trouble, please take off the water inlet hose and drain out the water in the hose and inner tub.
  - b) If the water freeze, please don't operate the washing machine. Put 40°C hot water in the tub, the hot water should submerge the pulsator, after a few minutes, rotate the pulsator by hand gently, then you can operate the washing machine.

Cycle	Description
Cottons	You can wash your lightly soiled cotton and linen laundry (sheets, bedlinen, towels, bathrobes, underwear etc.) in this programme. Wash and soak time could be set according to the soil level of the clothes.
Heavy	You can wash your heavily soiled durable cotton laundry in this programme.
Delicates	For sheer fabrics, bras, lingerie (silk), and other handwash-only fabrics.
Cottons Eco*	You can wash your normally soiled durable cotton laundry in this programme with the most energy and water efficient way.
Quick	Use this program to wash your lightly soiled garments such as sportswear quickly. Recommended for up to 2kg.
Woolens	You can wash your woollen clothes in this programme.
Baby Care	For baby's clothes.
Daily	Use this program to wash your daily laundry made of various cotton and easy care fabrics. Recommended for up to 6 kg
Drum Clean	Select this program to clean the tub and the drum. The powerful spinning removes the detergent residue and dirt from inside the tub and drum.
Air Dry	Select this to dry the tub and the drum. The powerful spinning removes moisture inside the tub to avoid mould formation.
*Energy label programme (AS/NZS 2040)	

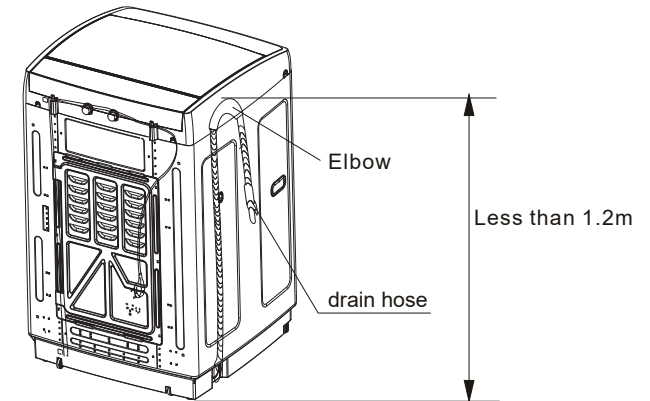

- 1.the drain hose must be hanged during use, the height should be no more than 1.2m to avoid leakage or stop. If drain a long time, the machine will stop running.
- 2.You can adjust the situation of the elbow bend pipe to change the height of the drain hose.
- 3.Do not make an extension to drain hose to ensure proper draining of water.

# Water inlet installation

Before using

**Caution:** When installing the washing machine, please use the new hose assembly along with the washing machine, old hose assembly should not be re-used.

## Tap selection

Suitable tap

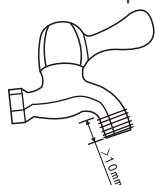

Not suitable tap

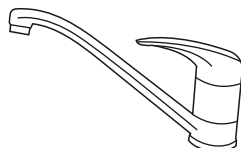

The front end should be longer than 10mm. The tap exit end face should be flat and smooth, if not file it to avoid leakage.

## Check the connection between inlet hose connector and the tap

1. Swing the inlet hose gently to confirm if it is fastened.
2. After installation, open the tap and check if it leaks.
3. Do not bend the inlet hose with overstrain.
4. Before each usage, check the connection between inlet hose connector and the tap. Make sure they are firmly fitted to prevent dropping from improper installation position.

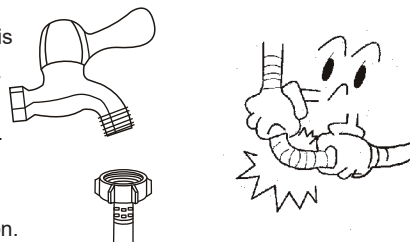

## Connect the inlet hose with the washing machine

1. Do not take off the water absorption cushion. Please check if the cushion is dropped or damaged before each usage. If it is, contact an Authorised Service Agent or qualified professional immediately.
2. Put the inlet hose nut on the inlet valve connector.
3. Fasten the inlet hose nut and swing it gently to make sure it is suitable.

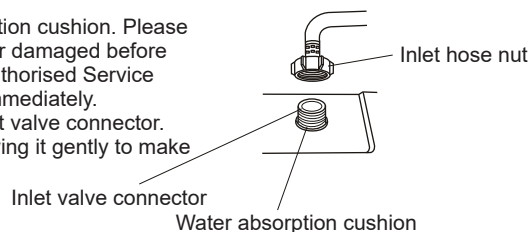

# Control panel instructions

Program Operation



- At the beginning of start, press this button to select preset time from 2-24 hours.
- If want to cancel preset time, press "POWER" to make the washing machine in waiting state.
- If need to select air dry, please press "PROGRAM" button to select airy dry, then press this button to set air dry time.
- At the beginning of start, pressing "WATER LEVEL" button and press "PRESET/AIR DRY/SPEED" button and choose inverter wash or inverter spin, and press it again, then you can choose washing speed or spin speed. This function is only applicable to "COTTONS" and "HEAVY" program. digital screen display the corresponding rotational speed as follows:

Speed R/min		Speed R/min	
140 (14)		700 (70)	
130 (13)		650 (65)	
120 (12)		600 (60)	
100 (10)		500 (50)	
80 (08)		400 (40)	
Washing speed	Digital display	Spin speed	Digital display
Inverter wash		Inverter spin	



- At the beginning of start, if with FUZZY logic and do not select water level, the digital timer shows "-". At this time, before press START/PAUSE, If select COTTONS or HEAVY, with fuzzy logic. When select COTTONS ECO, no fuzzy logic, the water level is "6"; When select QUICK, no fuzzy logic, water level is "2". If no WASH process, no fuzzy logic.
- At the beginning of start, press WATER LEVEL to select water level, at this time, no fuzzy logic function, you can select appropriate water level. According to your clothes quantity. 1-2 is low water level, 3-6 is middle water level, 7-10 is high water level.
- During wash (including rinse), if need to add water, press WATER LEVEL button to add water, un-press will stop adding. Or PAUSE the washing machine and press WATER LEVEL to select higher water level, then press START/PAUSE button, The washing machine Will add the water to setting level automatically and continue working. If your resetting water level is lower than present water level, the lower water level will valid in next water inlet.
- Automatically add water: during SOAK, WASH and RINSE process, if the washing machine check the water level is lower than setting water level, The washing machine will pause and add water to setting water level automatically.



- DIY (Do it yourself) program---- you can set spin time.
- At the beginning of start, the spin time setting is "7 minutes".
- At the beginning of start, you can press "SPIN" to set spin process only, press "SPIN" again to set spin time.



- DIY (Do it yourself) program---- you can set rinse times.
- At the beginning of start, the rinse times setting is "2 times".



- DIY (Do it yourself) program---- you can choose soak function and wash time.
- Pressing "WASH" button for 2 seconds to choose soak function, pressing for 2 seconds again to cancel soak function.
- Under "COTTONS", "HEAVY" programs to choose soak function, the soak is before wash.
- At the beginning of start, the wash time is "15 minutes".

To start, press POWER button, the machine is in the state of beginning of start:

1. If there is no water in inner tub, washing machine is in "FUZZY" condition, washing time is "15 minutes", rinse time is "2 times", spin time is "7 minutes", water level and preset are displayed "-", program is "COTTONS" If press "START/PAUSE" button (or press "PROGRAM" to select "HEAVY"), the washing machine will start to sense and automatically sense the weight of clothes and set water level.
2. If there is water in inner tub, the washing machine is not in "FUZZY" condition, washing time is "15 minutes", rinse time is "2 times", spin time is "7 minutes", water level is "7", program is "COTTONS", digital time displays the time to finish washing.





# Control panel instructions

## Program Operation

### Control Panel

Mode and meaning of the indicator light

-  On : Indicates the selected mode.
-  Flashing : Indicates the program is running.
-  Flashing rapidly : Indicates abnormal.

Soak	9 min
20 min	4
15 min	3
12 min	2
9 min	1
	Soft spin



Cottons	Woollens
Heavy	Baby Care
Delicates	Daily
Cottons Eco	Drum Clean
Quick	Air Dry
	Warm



- ADDITIONAL FUNCTION**
- At the beginning of start, pressing "WATER LEVEL", at the same time press "PRESET/AIR DRY/SPEED", you can select WATER RECYCLE, INVERTER WASH, INVERTER SPIN. Only both RINSE and SPIN are selected, WATER RECYCLE can be selected. When you choose INVERTER WASH, INVERTER SPIN, and press "PRESET/AIR DRY/SPEED" to choose a different washing speed and spin.
  - During working, press "WATER LEVEL" and "PRESET/AIR DRY/SPEED" to set CHILD LOCK, press again to unlock this function.



- During delay start, the screen will display the selected time in hours.
- If selecting AIR DRY, the Digital Timer displays air dry time, unit is Minutes.
- When washing, the Digital Timer shows the remaining time of washing, unit is Minutes
- When trouble encountered, the Digital Timer shows trouble code.
- When it is ON and if with Fuzzy logic, the Digital Timer shows "--".



- To switch on the Washing Machine to working state or waiting state.



- After selecting the PROGRAM, PRESET and WATER LEVEL, press this button to start. Press this button to pause during working, press again to continue.



- Press "TEMP. SELECT" to select "HOT"、"COLD" or "WARM" water for wash.
- During the rinse process, it will inlet cold water.



- Select one program from COTTONS, HEAVY, DELICATES, COTTONS ECO, QUICK, WOOLLENS, BABY CARE, DAILY, DRUM CLEAN and AIR DRY.
- If choose "COTTONS ECO" program, the wash time is "20 minutes", spin times is "4", spin time is "9 minutes".
- If choose "QUICK" program, the wash time is "9 minutes", spin times is "1", spin time is "3 minutes", you can cancel one of the process (but if you choose "SOAK", the wash time can not be cancelled).
- If no selection is selected, the process will start with the COTTONS program when the "START/PAUSE" button is pressed.

# Preparation before operation

## Operation

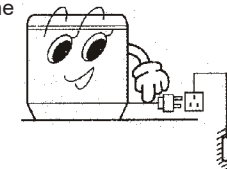

Preparation before washing

1. Connect the inlet hose and open the tap.
2. This appliance must be earthed. Confirm the socket is earthed reliably and insert the power plug. The earth terminal should not link to gas pipeline, tap pipeline etc.
3. Hang up the drain hose.

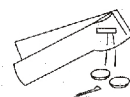

**Warning: the temperature of the water should be less than 50°C!**

**Before washing the clothes, please pay attention to the followings:**

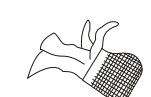
<p>Make sure if there is special requirements for the clothes</p>	<p>Before washing, empty all pockets of small objects which may have been left inside (coins, keys, screws etc.) .</p>	<p>Knot the long band, fasten the buttons and close the zippers.</p>	<p>Do not overload the machine. Load the laundry loosely alternating large items with small ones.</p>	<p>Sort the laundry according to the type of fabric, color-fastness and how dirty it is. Put thin clothes, woollens and such prone to wear and tear clothes into washing bag.</p>
				

- A. Make sure the clothes are washable.
- B. It is essential to wash new coloured items separately when washing for the first time. White items should not be washed with coloured items.
- C. Please emerge the non-absorbable clothes by hand.
- D. Some stains such as fruit, wine, grass, rust etc. are difficult to remove and should be treated before washing with specific products, which can be found in most household shops. In some cases it may help to soak the stain before washing with a special pre-soak product or biological detergent.
- E. Overtum the nap fabric and long floss clothes before putting them into the machine.
- F. Do not put the clothes polluted by chemicals into the machine directly.
- G. Very small item (handkerchiefs, ribbons, socks etc) should be washed in a washing bag or a pillow case.



- The capacity of washing and spinning of the machine refers to the largest weight of the standard clothes under dry condition. Washing quantity shall be lower than the rated capacity. The maximum capacity of this machine is 10.0kg.
- Different thickness, size and type of the clothes will influence the actual washing capacity.
- Do not select high water level when clothes are less than 1.5kg to avoid water splashing.

## Use of detergent

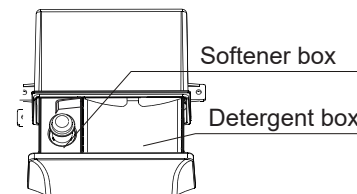

Please put the required liquid Detergent / washing powder in the detergent box and softener in softener box evenly

### How to use softener

- The machine automatically adds the softener to the inner tub during the last "rinse" process.

### How to use bleach

- Fill water to the selected level, dilute the bleach in the container, and pour it slowly into the washing tub.
- Do not use bleach for coloured or figured clothes as they are prone to lose colours.
- Do not put bleach to clothes directly.
- Refer to the manual for the usage and quantity of the bleach.
- Please dissolve powder bleach before use.

### Alternative ways to use the liquid Detergent / washing powder

- Dissolve in the machine directly (not suitable for preset program)
  1. Low water level.
  2. Add the washing powder, and run for 30 seconds to dissolve it completely.
  3. Put laundries in and select suitable water level.
- The instant dissolving of the washing powder
  1. Prepare warm water of 30°C in a container.
  2. Pour the powder while stirring to fully dissolve it.
- Washing powder with poor quality or not used for a long period may get blocked, please clean the detergent box in time.

Remarks: avoid splashing of water and waste of washing powder, water level should not be too high if clothes are too small.